

M LEVELO



Levelo

**Ambiance
Car Aroma Diffuser**

SKU: LVL-AMBDIF

Table of Contents

Introduction	2
Schematic View	2
Instructions for Use	3
Indicator Light Guide	4
Specifications	4
Warning	6
FAQ	7
Disposal	7
Warranty	8
Contact Us	8

Introduction

Thank you for purchasing the waterless aroma diffuser. This device utilizes advanced cold diffusion technology, which means there is no need to add water or heat. It atomizes essential oils into fine particles ranging from 1 to 3 nanometers in size, ensuring that the oil's integrity is preserved. This method allows the body to absorb the aromatic molecules more efficiently, potentially enhancing your health, improving sleep quality, and alleviating stress.

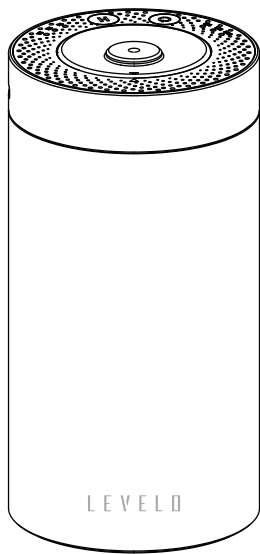

Aroma diffuser



Nozzle with empty bottle

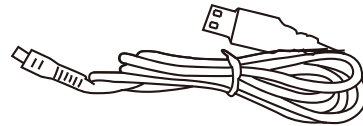

Type-C cable

Schematic View

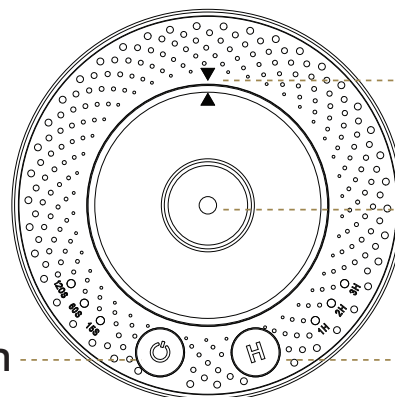

Nozzle Alignment

Mist Output

Power and Intermittent Button

Timer

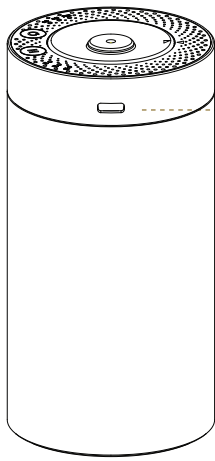

Type-C Charging Port

The nozzle and empty bottle can be easily removed from the .diffuser

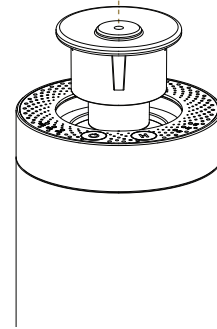

Instructions for Use

1. Gently press the nozzle. The empty bottle attached to the nozzle will pop up automatically.

2. Detach the bottle from the nozzle, and refill it with your preferred essential oil.

3. Reattach the bottle with the nozzle to the diffuser. Ensure that the alignment marks on the nozzle and the diffuser are properly matched.

Note: Pay close attention to ensure that the alignment marks (▲) on the unit and the (▲) marks on nozzle and the diffuser. Once properly installed, the (▲) marks should align with each other.

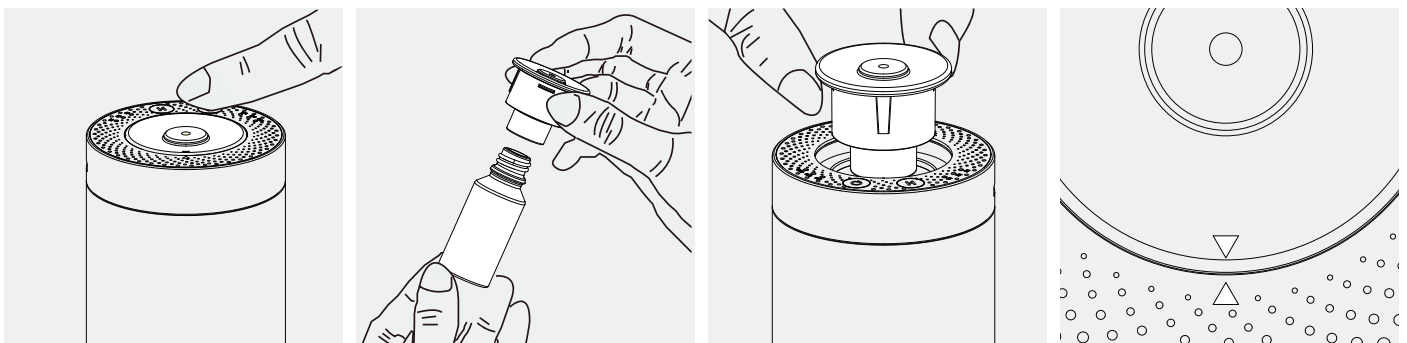

4. To turn the diffuser on, press and hold the on/off button (⏻) for two seconds. The diffuser will activate, and the on/off button (⏻) will

light up green.



5. To turn the diffuser off, press and hold the on/off button () for two seconds again.

Note: When you turn on the diffuser for the first time, it is set to intermittently spray every 15 seconds and includes an 8-hour timer for automatic shutdown. The indicator light will be green during operation.

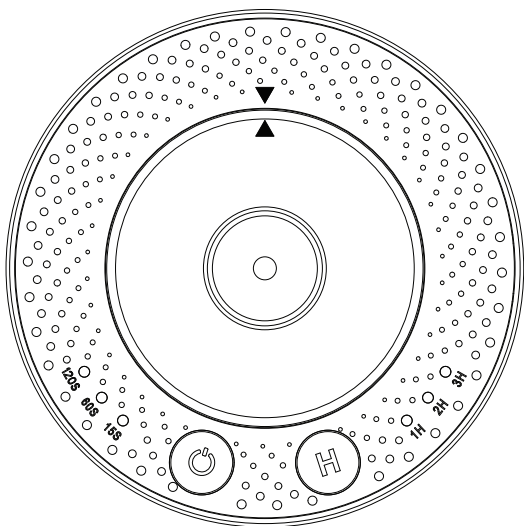
6. After turning on the diffuser, the default spray interval is set at 15 seconds. To change the intermittent spray timing, lightly tap the on/off button. You can select from 60 ,15, or 120 seconds for the spray interval. The indicator light will remain green to show the diffuser is in operation.



15sec	-----	15s Mode: Mists for 15 seconds, then pauses for 165 seconds before cycling again.
60sec		
120sec		
15sec		60s Mode: Mists for 60 seconds, then pauses for 120 seconds before cycling again.
60sec	-----	
120sec		
15sec		120s Mode: Mists for 60 seconds, then pauses for 60 seconds before cycling again.
60sec		
120sec	-----	

7. After turning on the diffuser, the default timer is set to 8 hours. To adjust the timer, lightly tap the () button. You can select from three timer settings: 1 hour, 2 hours, or 3 hours. Once set, the () button and the timer indicator light will turn green.

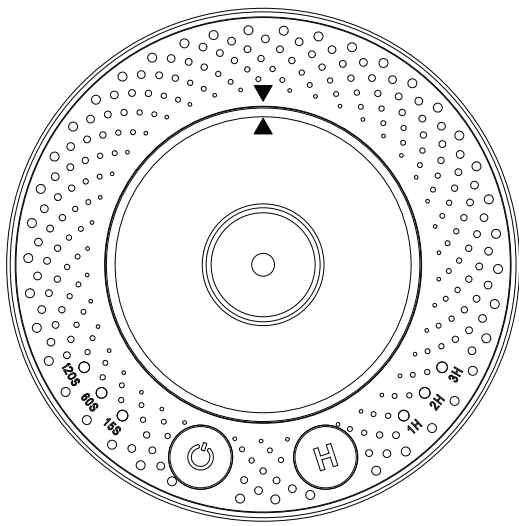

1H ----- Auto off after 1 hour
2H
3H
1H
2H ----- Auto off after 2 hour
3H
1H
2H
3H ----- Auto off after 3 hour

Indicator Light Guide

Charging: The on/off button (⏻) shows a solid green light.

Power Off: The on/off button (⏻) flashes with green light.

Turned On: The on/off button (⏻) displays a solid green light.

Turned Off: The on/off button (⏻) does not light up.

Specifications

Battery/Power	2000mAh/5W
Charging	DC 5V 1A
Spray Sequence	Delivers mist 15s, followed by a 165s pause Delivers mist 60s, followed by a 120s pause Delivers mist 120s, followed by a 60s pause
Timer Setting	1H/2H/3H
Working Time	14H Max
Charging Time	5H

Storage Capacity	10/20ml
Material	Aluminum+Plastic
Product Size	72x72x142mm

Warning

1. After installing and using the product, do not turn or tilt it. Otherwise, the oil may drain and damage the air pump, resulting in permanent damage to the product.
2. Do not modify or disassemble this product, as doing so will void the warranty.
3. Do not use this product when temperatures are too high (above 50°C) or too low (below 10°C).
4. If not in use for an extended period, remove the nozzle and diffuser and store them separately.
5. Always turn off the power switch when changing the oil.
6. Keep out of reach of children and pets.

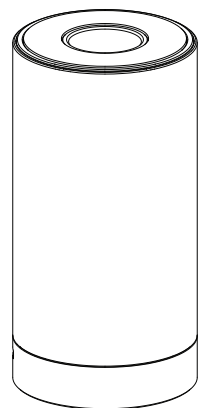
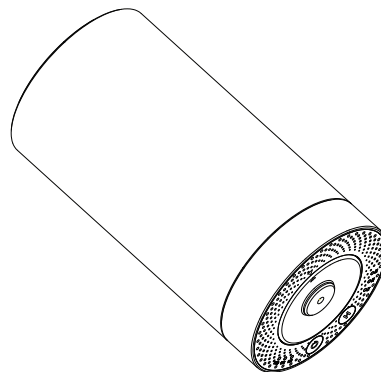
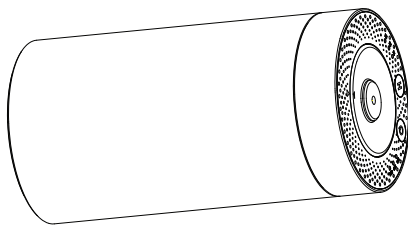
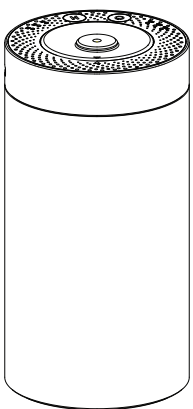

FAQ

1. How long does it take to fully charge the diffuser?

Answer: Approximately 2 to 3 hours.

2. What type of essential oil should be used with this diffuser?

Answer: Use pure botanical essential oils or high-volatility oils without impurities.

3. What if I can't see the mist when diffusing?

Answer:

a. This is normal. The diffuser has a function to adjust the mist output to conserve essential oil.

b. The atomizing particles are only 1 to 3 nanometers in scale, making them difficult to see with the naked eye.

Disposal

This product must not be disposed of as unsorted household waste. It is important to separate such waste for proper treatment and recycling, in compliance with local waste management regulations.



Warranty

Products procured directly from the **Levelo** website or physical store comes with a 24-month warranty. **Levelo** products purchased from any of our authorized dealers are guaranteed with a one-year warranty. If you wish to extend this warranty, you'll need to go to our website at <https://www.levelobrand.com/warranty> and fill out the necessary form, making sure to include your personal information and a photo of the product. After your request has been evaluated and accepted, we'll send you an email notification to affirm the extension of your product's warranty.

For more info, please check:

<https://www.levelobrand.com/warranty>

Contact Us

If you have any questions about this Privacy Policy, please contact us at: Info@levelobrand.com

Website: <https://www.levelobrand.com/>

Email: Info@levelobrand.com

Instagram: [levelobrand](#)

Facebook: [levelobrand](#)